

**ACCESSORI.
ACCESSORIES.**

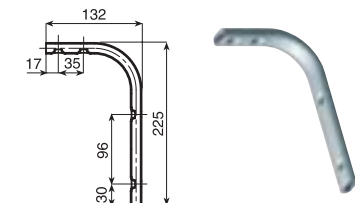

19-011-44
Mensola per pannello frontale.
Bracket for modesty panel.

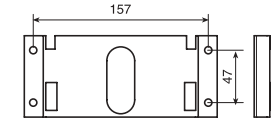

19-018-92
Attacco per traversa larga a 90°
(solo per pannello frontale).
90° connecting plate for wide beam
(only for modesty panel).

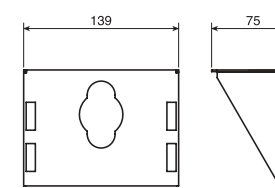

19-018-96
Attacco sotto il piano
per traversa larga.
Under-top connecting plate
for wide beam.

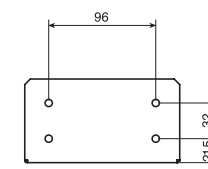

19-018-98
Piastra di collegamento piani tavolo.
Table-tops connecting plate.

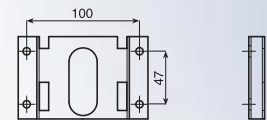
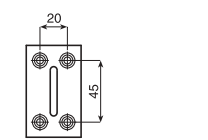

19-018-90
Attacco per traversa stretta a 90°
(solo per pannello frontale).
90° connecting plate
for narrow beam
(only for modesty panel).

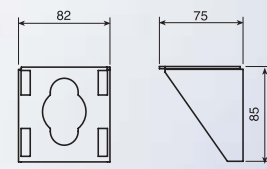

19-018-94
Attacco sotto il piano
per traversa stretta.
Under-top connecting plate
for narrow beam.

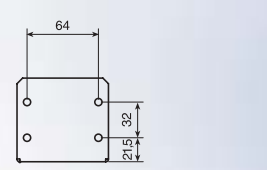

30-CAV-02
Portacavi in plastica per gamba
Plastic cables-rack for desk leg

30-CAV-03
Portacavi in plastica per piano
Plastic cables-rack for desk top

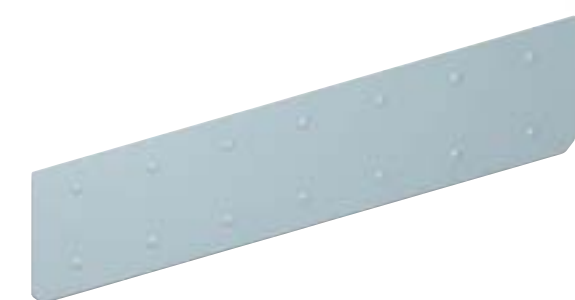

19-020-20/22/24/26/28
Frontale in lamiera.
Steel modesty panel.

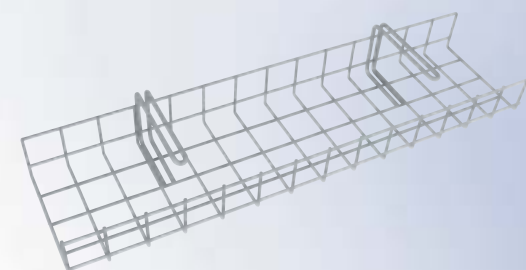
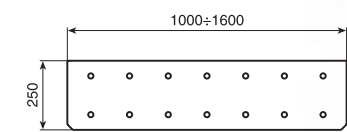

32-905-09
Cestello portacavi mm 700.
Basket for cables 700 mm.

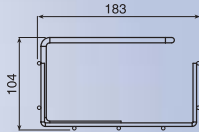

19-200-02
Portaserver pensile regolabile.
Adjustable hangin CPU holder.

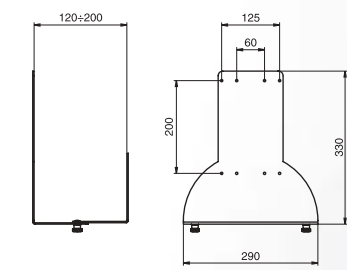

19-200-04
Portaserver regolabile su ruote.
Adjustable CPU holder on wheels.

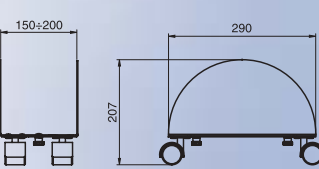

CONFIGURAZIONI PIANI TAVOLO TABLE-TOPS CONFIGURATIONS
Gambe-traverse fisse/regolabili Legs-fixed/adjustable beams

LEGENDA
A = gamba 700
B = gamba 600
C = gamba interm. 700
D = gamba interm. 600
E = gamba centrale
F = traversa principale
G = traversa angolare
H = traversa terminale
I = collegamento piani

LEGEND
A = leg 700
B = leg 600
C = intermed. leg 700
D = intermediate leg 600
E = central leg
F = main beam
G = corner beam
H = terminal beam
I = tops connection

Maggio 2004
La Mara si riserva il diritto di apportare in qualsiasi momento modifiche costruttive e funzionali. Mara has the right to modify its product at any time.



**Componenti
per
Scrivanie
Components for desks**

**Componenti per
Scrivanie Robusti - Pratici - Versatili**



Gamma completa di componenti per scrivanie fisse e regolabili in altezza. Progettate per organizzare lo spazio dell'ufficio automatizzato, risponde ampiamente alle esigenze di un arredo di linea sobria e moderna. La finitura delle superfici è con verniciatura a polveri. I piedi sono provvisti di supporti regolabili. Le gambe e le travi sono elettrificabili con il cavo di alimentazione elettrica, il cavo coassiale per il computer e il cavo per alimentazione telefonica. I componenti sono modulari fra loro, smontabili, aggregabili. Sono stati inoltre progettati diversi angoli di raccordo per consentire una combinazione illimitata di configurazione.

**Components for desks
Strong - Practical - Versatile**
Full range of components for standard and height-adjustable desks. Designed as complete solutions for the space planning needs of the modern automated office. The components for desks are made in steel plate finely shaped and painted with epoxy-powders. The legs are provided with height adjustable feet. The legs and the beams are also able to accept service system cable, fitted with three separate connection points for the electricity main supply, the coaxial computer network cable and the telephone line. The system offers an extraordinary versatility to the ease, because the different desks can be joined together, to make every model modular, sectional and simple to disassemble. Enhancing this, both systems include a wide range of specially designed corners connecting surfaces, enabling to achieve an infinite variety of layouts.

19-010-82B (8050)
Gamba per scrivania.
Desk leg.



19-012-22 (8011)
Gamba per scrivania.
Desk leg.



19-012-07 (8010)
Gamba per scrivania.
Desk leg.
19-012-07A (8015)
Gamba per scrivania piede corto.
Desk leg short foot.

19-010-95 (8060)
Gamba per scrivania piede corto.
Desk leg short foot.



19-011-32 (9011)
Gamba per scrivania.
Desk leg.
19-011-32B (9021)
Gamba per scrivania intermedia.
Intermediate desk leg.
19-011-32C (9015)
Gamba per scrivania piede corto.
Desk leg short foot.
19-011-32D (9035)
Gamba per scrivania intermedia piede corto.
Intermediate desk leg short foot.



19-011-54 (9010)
Gamba per scrivania.
Desk leg.
19-011-54A (9115)
Gamba per scrivania piede corto.
Desk leg short foot.
19-011-54B (9125)
Gamba per scrivania intermedia.
Intermediate desk leg.
19-011-58 (9135)
Gamba per scrivania intermedia piede corto.
Intermediate desk leg short foot.

19-010-81A (8300)
Gamba per scrivania.
Desk leg.



19-014-00 (9700)
Gamba scrivania per pannello frontale.
Desk leg for modesty panel.
19-014-01 (9710)
Gamba scrivania per pannello frontale piede corto.
Desk leg for modesty panel short foot.



19-011-84 (8000)
Gamba per scrivania.
Desk leg.
19-011-84A (8005)
Gamba per scrivania piede corto.
Desk leg short foot.

19-010-96 (8200)
Gamba scrivania per pannello frontale.
Desk leg for modesty panel.



19-013-96 (9600)
Gamba scrivania per pannello frontale.
Desk leg for modesty panel.
19-013-94 (9605)
Gamba scrivania per pannello frontale piede corto.
Desk leg for modesty panel short foot.



19-011-22 (9000)
Gamba per scrivania.
Desk leg.
19-011-22A (9005)
Gamba per scrivania piede corto.
Desk leg short foot.
19-011-22B (9020)
Gamba per scrivania intermedia.
Intermediate desk leg.
19-011-22C (9025)
Gamba per scrivania intermedia piede corto.
Intermediate desk leg short foot.

GAMBE SCRIVANIA REGOLABILI CON PASSO MM 30 A 5 POSIZIONI.
HEIGHT-ADJUSTABLE DESK LEGS 30 MM EXCURSION WITH 5 POSITIONS.



19-011-78 (8500)
Gamba regolabile.
High-adjustable leg.
19-011-78A (8505)
Gamba regolabile piede corto.
High-adjustable leg short foot.

19-010-62 (9550)
Gamba regolabile.
High-adjustable leg.
19-010-62A (9555)
Gamba regolabile piede corto.
High-adjustable leg short foot.

19-011-24 (9500)
Gamba regolabile.
High-adjustable leg.
19-011-24A (9505)
Gamba regolabile piede corto.
High-adjustable leg short foot.

TRAVERSE DI COLLEGAMENTO.
CONNECTING BEAMS.



19-010-84
Traversa regolabile mm 800/1200.
Adjustable beam 800/1200 mm.

19-010-86
Traversa regolabile mm 1200/2000.
Adjustable beam 1200/2000 mm.

19-010-88/19-012-88/19-014-88/19-016-88/19-018-88
Traversa fissa mm 800/1200/1600/1800/2000.
Fixed beam 800/1200/1600/1800/2000 mm.

19-011-32A
Traversa regolabile per mm 800/1200 gamba disassata.
Adjustable beam 800/1200 mm for off-centre leg.

19-011-34A
Traversa regolabile mm 1200/2000 per gamba disassata.
Adjustable beam 1200/2000 mm for off-centre leg.

19-010-99
Traversa angolo regolabile.
Adjustable corner beam.

19-100-85
Traversa terminale.
Terminal beam.

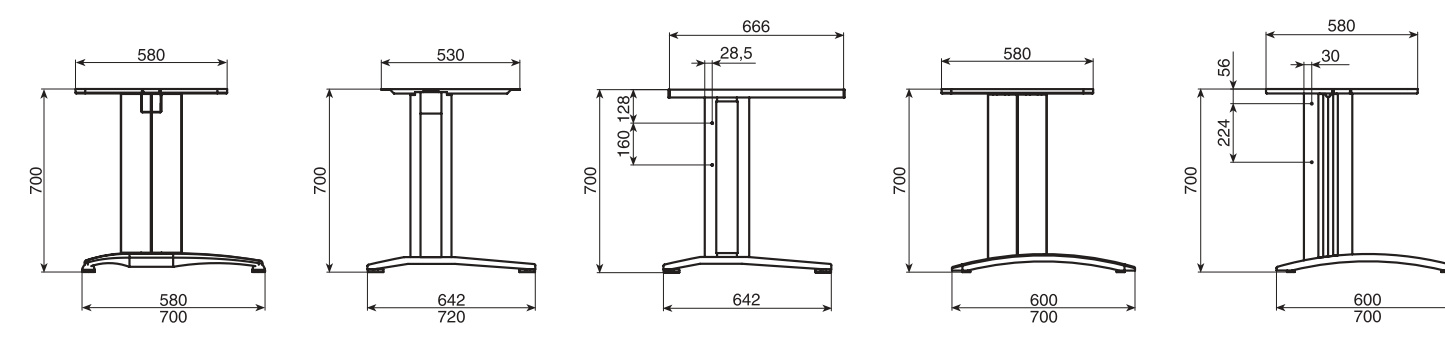

GAMBE TONDE INTERMEDIE.
INTERMEDIATE ROUND LEGS.



19-010-91 (9040)
Gamba Ø 80 regolabile a 2 vie.
High-adjustable leg Ø 80 with 2 ways.
19-010-91A (9040A)
Gamba Ø 80 regolabile a 3 vie.
High-adjustable leg Ø 80 with 3 ways.
19-010-91B (9040B)
Gamba Ø 80 regolabile a 4 vie.
High-adjustable leg Ø 80 with 4 ways.

19-010-71A (8037)
Gamba Ø 80 regolabile.
High-adjustable leg Ø 80.

19-010-69 (8036)
Gamba Ø 80 fissa.
Fixed leg Ø 80.



19-012-42 (8039)
Gamba Ø 60.
Leg Ø 60.

19-010-79 (8038)
Gamba Ø 60 a 2 vie.
Leg Ø 60 2 ways.
19-010-79A (8038A)
Gamba Ø 60 a 3 vie.
Leg Ø 60 3 ways.
19-010-79B (8038B)
Gamba Ø 60 a 4 vie.
Leg Ø 60 4 ways.

19-010-80 (8040)
Gamba Ø 121 fissa.
Fixed leg Ø 121.

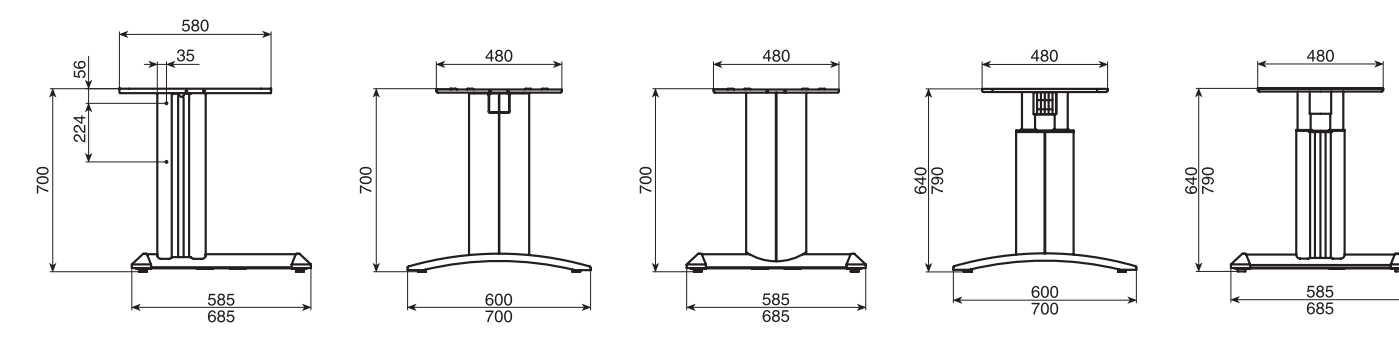

CARTER IN ACCIAIO - COPERTURE (Tipologie di lavorazione).
STEEL CARTES - COVERS (Different models).

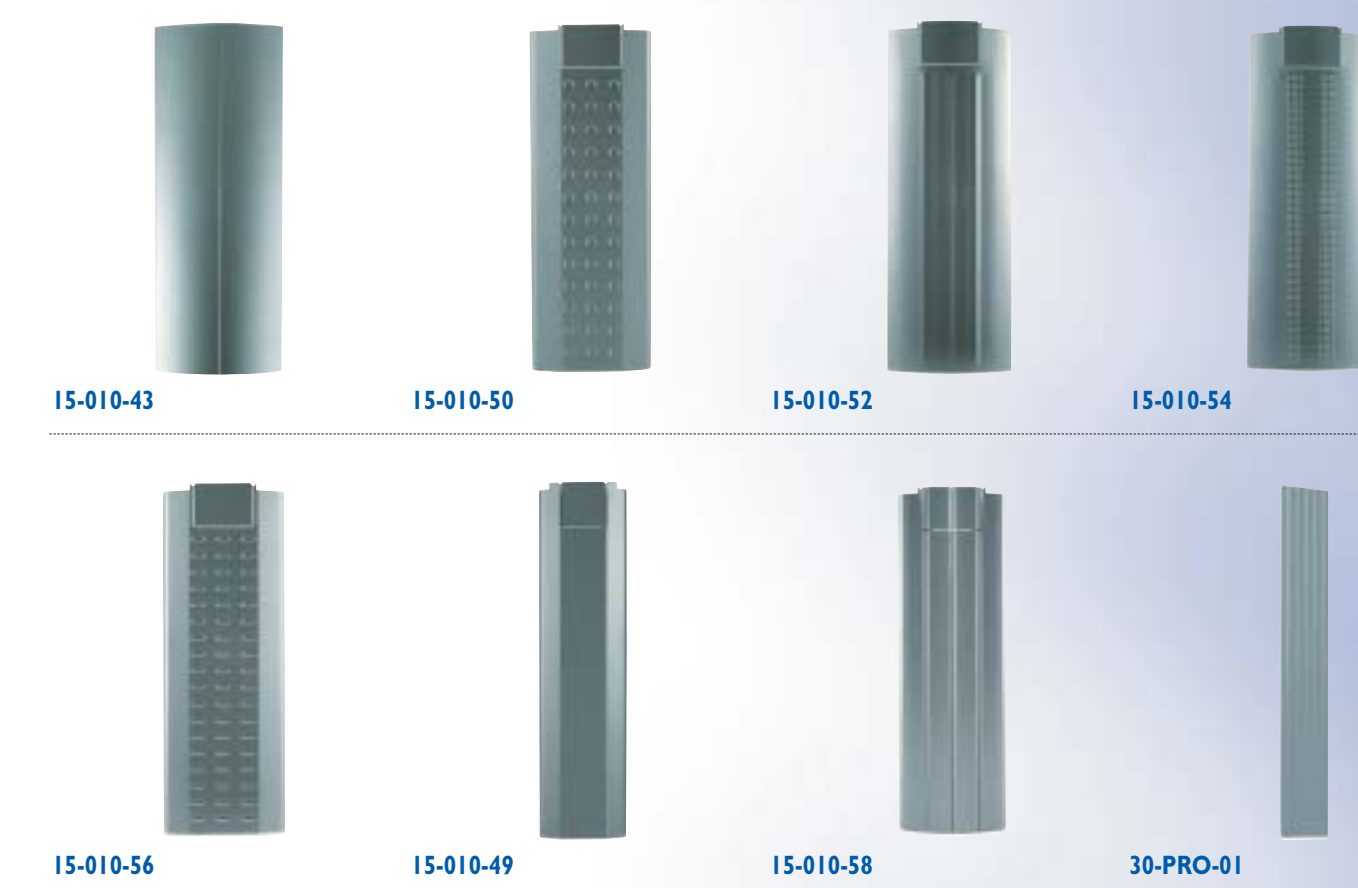

STRUTTURE GAMBE SCRIVANIA.
COMPONENTS FOR DESK LEGS.



INTERASSI FORI MENSOLE.
INTER-AXES FOR THE TOP PLATES.

Mensola per 19-010-81.
Bracket for 19-010-81.

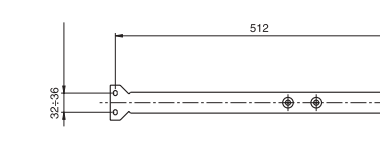

Mensola per gambe centrali e regolabili.
Bracket for central and adjustable legs.

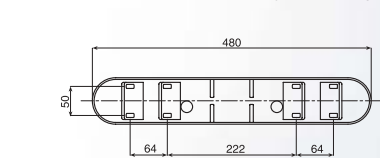

Mensola per gambe disassate.
Bracket for off-centre legs.

