

TIMMY LIBRO H1050
294H



DESCRIPTION / DESCRIZIONE

en Timmy Libro H1050 mm is a new version of Timmy collection.
A space-saving table that can be folded in 50 cm featuring a top 1050 mm high.
An even more versatile solution for stand or seated meetings that offers a great flexibility and dynamics to different environments: from workplace to hospitality.
The mechanical folding system allows one person only to easily open the table. Once closed it can be troubleless moved through doors and elevators as well as stored in small spaces.
Timmy Libro is provided with the exclusive antishock system, designed and patented by Mara.

it Timmy Libro H1050 mm è una nuova versione della collezione Timmy.
Un tavolo salvaspazio richiudibile in soli 50 cm caratterizzato da un'altezza del piano di 1050 mm.
Una soluzione ancora più versatile ideale per incontri in piedi o seduti adatta a soddisfare esigenze di flessibilità e dinamicità in ambienti diversi: dall'ufficio all'hospitality.
Il sistema di chiusura meccanico rende questo tavolo facilmente manovrabile da una sola persona.
Una volta richiuso passa con facilità da porte e ascensori e può essere riposto anche in piccoli spazi.
Timmy Libro è dotato dell'esclusivo sistema antishock brevettato Mara.

TIMMY LIBRO H1050
table with book closure
 tavolo con chiusura a libro

294H

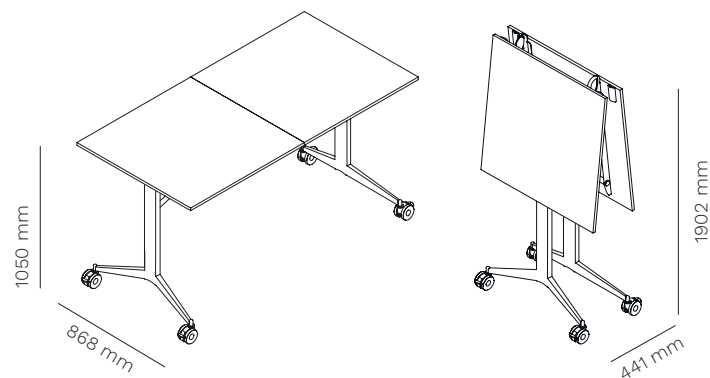

top
 2000/2600 x 900/1200 mm



patented system
 sistema brevettato



stackable
 impilabile



frame delivered assembled
 telaio fornito montato



1 FRAME 1 TELAIO	42 Kg	1 pc 0,99 mc	2 pcs / 130 x 110 cm pallet
----------------------------	-------	-----------------	--------------------------------

TIMMY LIBRO H1050
294H

mara[®]

INCLUDED ACCESSORIES / ACCESSORI INCLUSI



antishock system
sistema antishock



locking system and tops alignment
sistema di chiusura e allineamento piani



kit of 4 castors Ø 100 mm with integrated brakes
kit 4 ruote Ø 100 mm con freni integrati

ACCESSORIES / ACCESSORI

511PLUS



top access with flip cover
passacavi con sportello

511EPLUS



top access with multifunctional sockets
passacavi con prese multifunzione

PASD60



multifunctional sockets Ø 60 mm
prese multifunzione Ø 60 mm

PASD80



multifunctional sockets with wireless charging Ø 80 mm
prese multifunzione con ricarica wireless Ø 80 mm

215KIT



nylon kit for connection
agganci in nylon

350P



plastic cables-fixer for table top
portacavi in plastica per piano

500DROLL



mobile storage system, on castors
cassettiera mobile su ruote

FRAME / STRUTTURA

powder coated steel
acciaio verniciato



chromed steel
acciaio cromato



TOP / PIANO

standard colour and material effect laminate tops
piani standard in laminato colore ed effetto materico



standard colour and wood melamine tops
piani standard in nobilitato colore e legno



standard FENIX tops
piani standard in FENIX

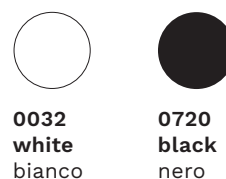

CLEANING AND MAINTENANCE / PULIZIA E MANUTENZIONE

STEEL / ACCIAIO

en Our types of metals include: chromed metals and painted metals. Do not use acid or alkaline based cleaning products. Do not use detergents, steel wool, dishwashing detergents or the like. Sharp or pointed objects may damage the surface. Any hot or wet object may cause surface damage. Clean the surface regularly with a soft cloth to remove dust. To remove light dirt, use a soft cloth and a neutral household cleaner.

it Le nostre tipologie di metallo comprendono: metalli cromati e metalli verniciati. Non utilizzare prodotti per la pulizia a base acida o alcalina. Non utilizzare detergenti, lana di acciaio, detersivi per stoviglie o simili. Oggetti appuntiti o taglienti possono danneggiare la superficie. Qualsiasi oggetto caldo o bagnato potrebbe provocare danni alla superficie. Pulire la superficie regolarmente con un panno soffice per rimuovere la polvere. Per rimuovere lo sporco leggero utilizzare un panno soffice e un prodotto per le pulizie di casa neutro.

CHROMED STEEL AND ALUMINIUM POLISHED / ACCIAIO CROMATO E ALLUMINIO LUCIDO

en Do not use acid or alkaline based cleaning products. Do not use detergents, steel wool, dishwashing detergents or the like. Sharp or pointed objects may damage the surface. Any hot or wet object may cause surface damage. Clean the surface regularly with a soft cloth to remove dust. To remove light dirt, use a soft cloth and a neutral household cleaner

it Non utilizzare prodotti per la pulizia a base acida o alcalina. Non utilizzare detergenti, lana di acciaio, detersivi per stoviglie o simili. Oggetti appuntiti o taglienti possono danneggiare la superficie. Qualsiasi oggetto caldo o bagnato potrebbe provocare danni alla superficie. Pulire la superficie regolarmente con un panno soffice per rimuovere la polvere. Per rimuovere lo sporco leggero utilizzare un panno soffice e un prodotto per le pulizie di casa neutro.

LAMINATE AND MELAMINE / LAMINATI E NOBILITATI

en Laminates and melamine products guarantee high performance in terms of resistance to scratches, shocks and abrasions. Keep furniture away from direct sunlight; furniture in direct sunlight may tend to discolour over time. Do not use acid or alkaline based cleaning products. Sharp or pointed objects can damage the surface. Laminate and melamine furniture can be cleaned using a mixture of liquid soap and hot water. Rinse with cold water and dry with a paper towel or damp cloth.

it Laminati e nobilitati garantiscono alte prestazioni di resistenza ai graffi, agli urti e alle abrasioni. Mantenere i mobili lontani dalla luce diretta del sole; i mobili che si trovano alla luce diretta del sole potrebbero tendere a scolorire nel tempo. Non utilizzare prodotti per la pulizia a base acida o alcalina. Oggetti appuntiti o taglienti possono danneggiare la superficie. E' possibile effettuare la pulizia dei mobili in laminato e nobilitato usando una miscela di sapone liquido e acqua calda. Sciacquare con acqua fredda e asciugare con un tovagliolo di carta o un panno umido.

STANDARD FENIX TOPS / PIANI STANDARD IN FENIX

en Cleaning FENIX means cleaning its structure. You can do this with warm water. As FENIX is a strong material, you can also use any household cleaner – even solvents like acetone * if needed. However, to avoid damaging the structure, don't scrub it with abrasive cream, a scouring pad or a hard brush; in the long-term, this might lead to a glossy spot on your matt surface. Instead, you can use a melamine sponge – also known as a magic sponge. As a final step, to avoid anything staying behind in the structure – whether that's dirt or residue from your cleaner – always rinse afterward with warm water and wipe dry with a clean cloth.

* always follow safety instructions

it Pulire FENIX significa pulirne la struttura. Si può farlo, usando acqua tiepida. Poiché FENIX è un materiale resistente, si può utilizzare qualsiasi detergente per la casa, se necessario anche un solvente come l'acetone *. Tuttavia, per evitare di danneggiare la struttura, è consigliabile evitare di strofinarla usando una crema abrasiva, una spugna abrasiva o una spazzola con setole dure; nel tempo, ciò potrebbe portare alla formazione di un'area lucida sulla superficie opaca. Si può piuttosto utilizzare una spugna in melamina, nota anche come spugna magica. Come ultimo passaggio, per evitare la formazione di depositi nella struttura, che si tratti di sporco o residui del detergente, risciacquare sempre con acqua tiepida e asciugare con un panno pulito.

* seguire sempre le istruzioni di sicurezza.

TOP ACCESS
PASSACAVI

511E

mara[®]

DESCRIPTION / DESCRIZIONE

en Aluminium top access with flap. Black brush.

it Passacavi in alluminio con spazzola nera.

* All measurements are indicated in mm

* Tutte le misure sono indicate in mm

Surface cut-out area

Area di taglio della superficie

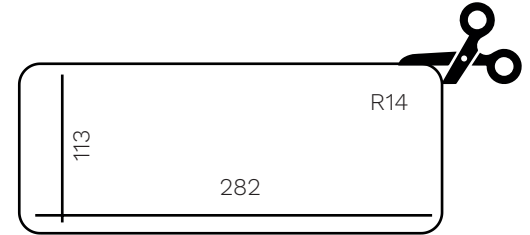
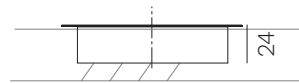
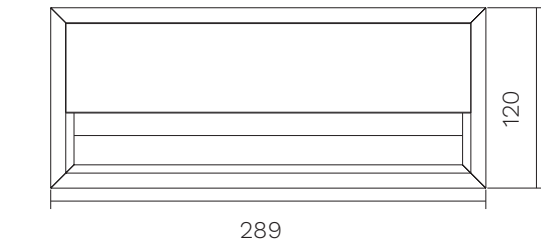

COLOURS AVAILABLE / COLORI DISPONIBILI



aluminium
alluminio



black
nero



TOP ACCESS WITH INTEGRATED POWER UNIT
PASSACAVALI CON MULTIPRESA INTEGRATA

mara[®]

511EPLUS

DESCRIPTION / DESCRIZIONE

en Top access with integrated power unit for table tops max 30 mm thick, available in aluminium or black colour, 289x120 mm with 2 mt. power cable + 2 DE sockets + 2 USB 5V/2, 4A + 2 RJ45 sockets.

it Passacavo con multipresa integrata per piani tavoli spessore max 30 mm, disponibile nei colori alluminio o nero, 289x120 mm con 2 mt. di cavo di alimentazione + 2 presa DE + 2 prese USB 5V/2, 4A + 2 prese RJ45.

* All measurements are indicated in mm
 * Tutte le misure sono indicate in mm

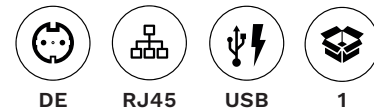

Optional (on demand)*:
 Opzionali (su richiesta)*:

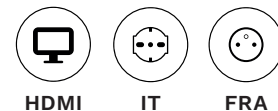

* dedicated quotation /quotazione dedicata

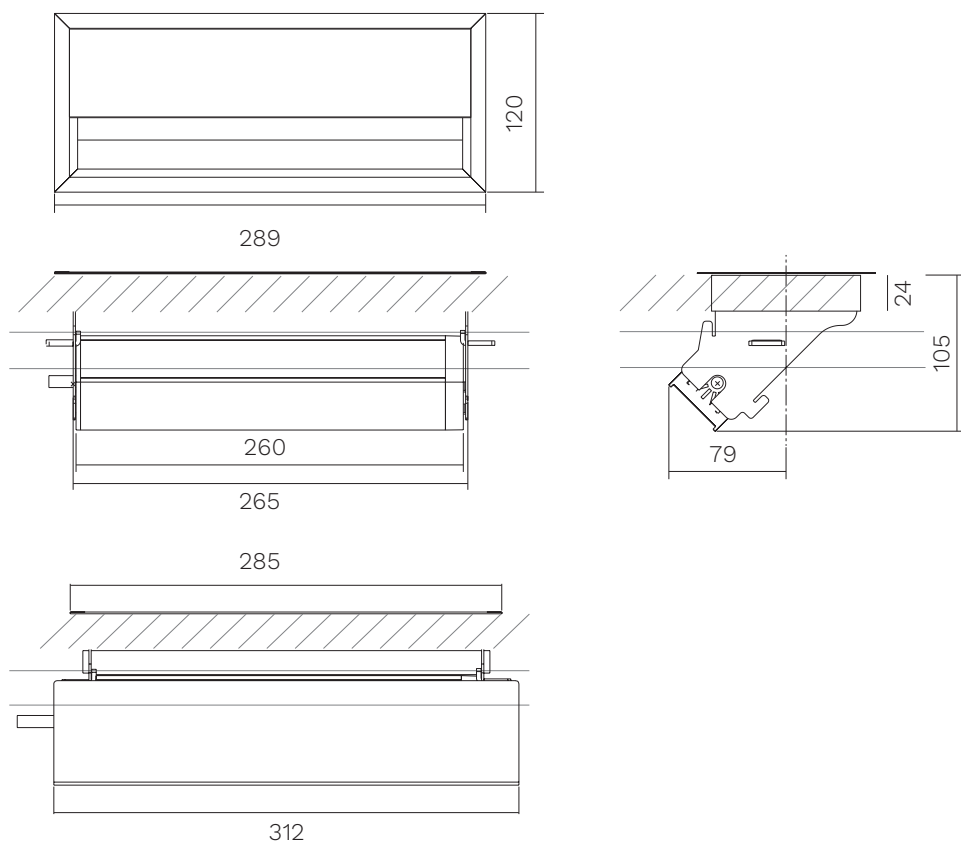

Surface cut-out area
 Area di taglio della superficie

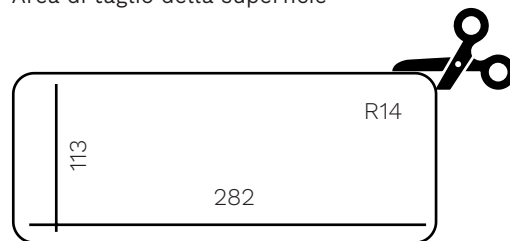

COLOURS AVAILABLE / COLORI DISPONIBILI

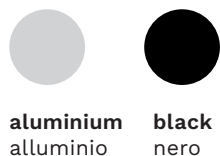

TOP ACCESS WITH INTEGRATED MULTIFUNCTIONAL SOCKET

PASSACAIVI CON MULTIPRESA INTEGRATA

mara®

PASD60

DESCRIPTION / DESCRIZIONE

en Top access round with integrated multifunctional socket for table tops, available in white or black colours, diameter 60 mm with 2 mt. power cable + 1 DE + 1 USB 5V/2, 4A socket.

it Presa multifunzione rotonda per piani tavoli, disponibile nei colori bianco o nero, diametro 60 mm con 2 mt. di cavo di alimentazione + 1 presa DE + 1 presa USB 5V/2, 4A.

* All measurements are indicated in mm
* Tutte le misure sono indicate in mm

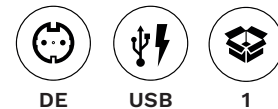

Optional (on demand)*:
Opzionali (su richiesta)*:

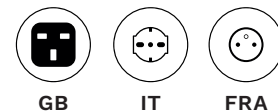

* dedicated quotation /quotazione dedicata

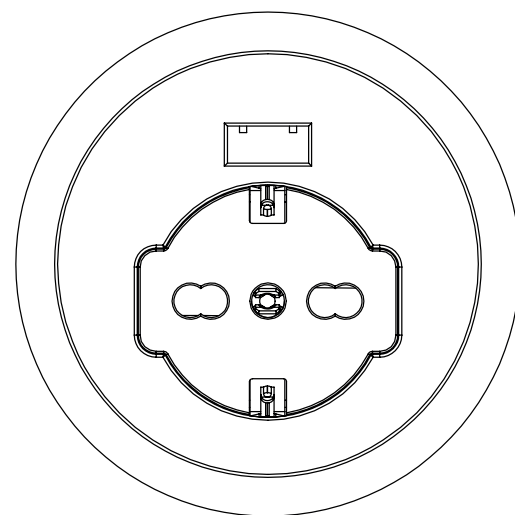
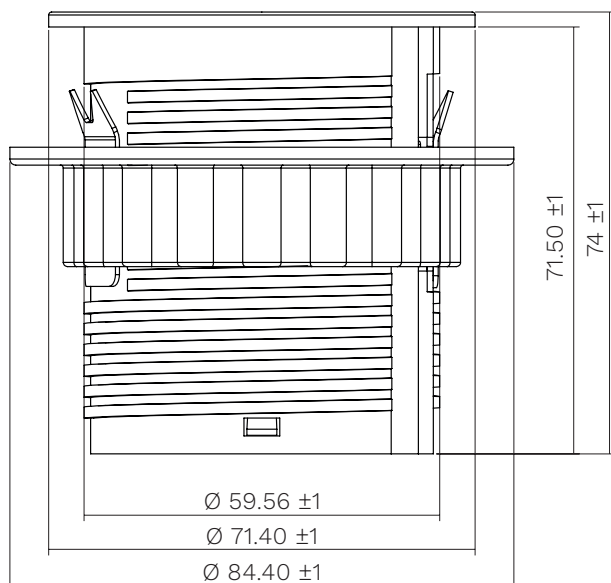

Surface cut-out area

Area di taglio della superficie

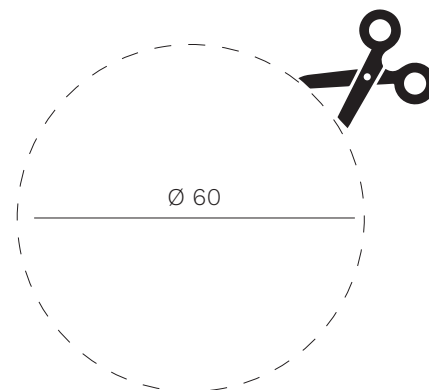

COLOURS AVAILABLE / COLORI DISPONIBILI



white
bianco



black
nero



REV032023

MARA SRL | Via Adua 11, 25050 Passirano (BS) Italy | T. +39 030 6857568 | marasrl.it

CABLE MANAGEMENT WITH INTEGRATED MULTISOCKET PASSACAPO CON MULTIPRESA INTEGRATA

mara[®]

PASD80

DESCRIPTION / DESCRIZIONE

en Top access round with integrated multifunctional socket for table tops, available in white or black colours, diameter 80 mm with 2 mt. power cable + 1 DE + 1 USB 5V/2, 4A socket + 1 RJ45 (interchangeable). The inside of the cover is equipped with a wireless charger (usable only when open).

it Presa multifunzione rotonda per piani tavoli, disponibile nei colori bianco o nero, diametro 80 mm con 2 mt. di cavo di alimentazione + 1 presa DE + 1 presa USB 5V/2, 4A + 1 presa RJ45 (intercambiabile). L'interno del coperchio è provvisto di caricatore wireless (utilizzabile solo quando aperto).

* All measurements are indicated in mm
* Tutte le misure sono indicate in mm

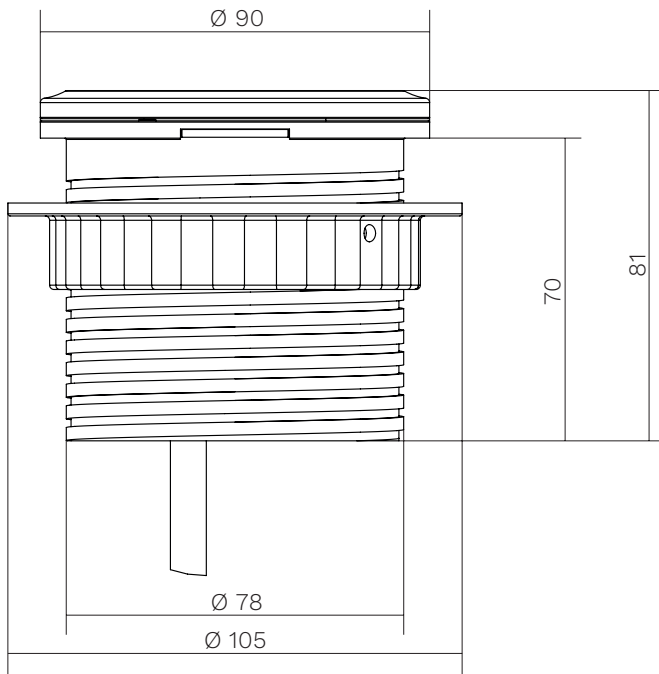

wireless recharge

RJ45

DE

USB

1

Optional (on demand)*:
Opzionali (su richiesta)*:

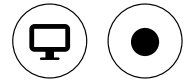

HDMI

EXIT



GB

IT

FRA

* dedicated quotation and minimum order
* quotazione dedicata e minimo d'ordine

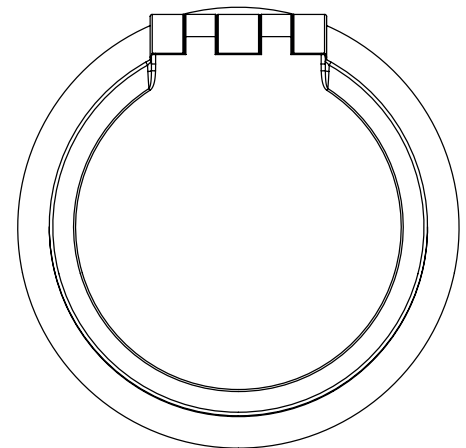

Surface cut-out area
Area di taglio della superficie

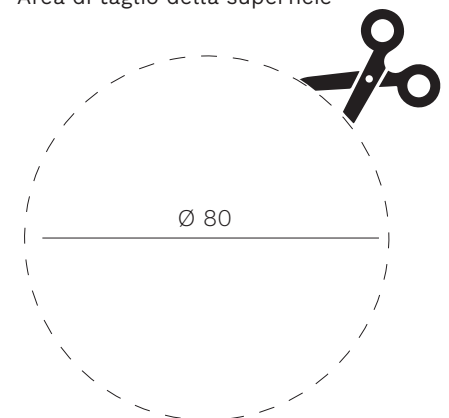

COLOURS AVAILABLE / COLORI DISPONIBILI



white
bianco



black
nero





en All the energy used in our company is 100% green and comes exclusively from renewable sources.

it Tutta l'energia utilizzata nella nostra azienda è 100% GREEN e proviene esclusivamente da fonti rinnovabili.

en As it is always seeking to improve its products, the company reserves the right to modify or upgrade the products without prior notice, at any time. Colors should be considered purely indicative. Mara's Collections are worldwide protected by the industrial property right and patents.

it Mara, sempre alla ricerca del miglioramento dei propri prodotti, si riserva la facoltà di apportare modifiche costruttive e funzionali in qualsiasi momento senza alcun preavviso. I colori dei materiali sono da ritenersi puramente indicativi. Tutte le collezioni Mara sono protette nel mondo dal diritto di proprietà industriale e da brevetti registrati.