

210, 210 ROLL
210, 210ROLL

DESCRIPTION / DESCRIZIONE

en 210 is a table collection that speak a simple, modern language.
The lightweight yet stable and sturdy metal frame can be fitted with practical castors and customised in different colours and finishes.

it 210 è una collezione di tavoli che parlano un linguaggio semplice e allo stesso tempo moderno.
La struttura in metallo, leggera ma stabile e robusta allo stesso tempo, può essere accessoriata con pratiche ruote e personalizzata in diversi colori e finiture.

210

210

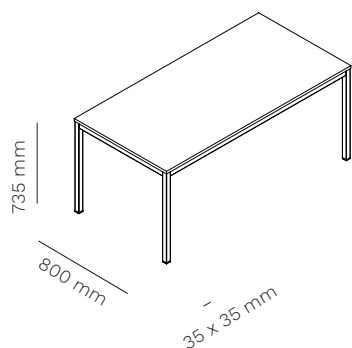

top
800/1200/1600/1800 x 800 mm

210 ROLL

210ROLL

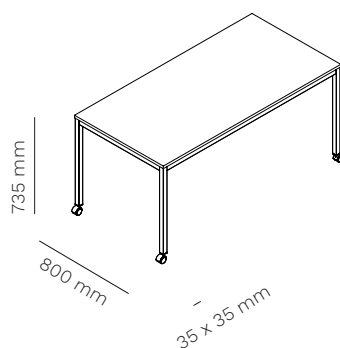

top
800/1200/1600/1800 x 800 mm

ACCESSORIES INCLUDED / ACCESSORI INCLUSI



4 castors Ø 50 mm with integrated brakes
4 ruote Ø 50 mm con freni integrati

only for art. 210ROLL
solo per art. 210ROLL

210, 210 ROLL
210, 210ROLL

mara[®]

ACCESSORIES / ACCESSORI

511PLUS



top access with flip cover
passacavi con sportello

511EPLUS



top access with multifunctional sockets
passacavi con prese multifunzione

PASD60



multifunctional sockets
Ø 60 mm
prese multifunzione
Ø 60 mm

PASD80



multifunctional sockets with wireless charging
Ø 80 mm
prese multifunzione con ricarica wireless Ø 80 mm

500DROLL



mobile storage system, on castors
cassetiera mobile su ruote

300

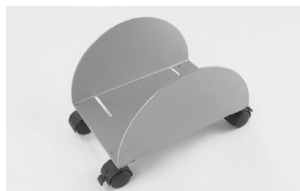

cpu holder
portaserver

8001



hanging cpu holder
portaserver pensile

215V



cable tray to fix under top (2,7kg)
vasca porta cavi fissaggio sotto piano (2,7 kg)

350P



plastic cables-fixer for table top
portacavi in plastica per piano

FRAME / STRUTTURA

powder coated steel
acciaio verniciato

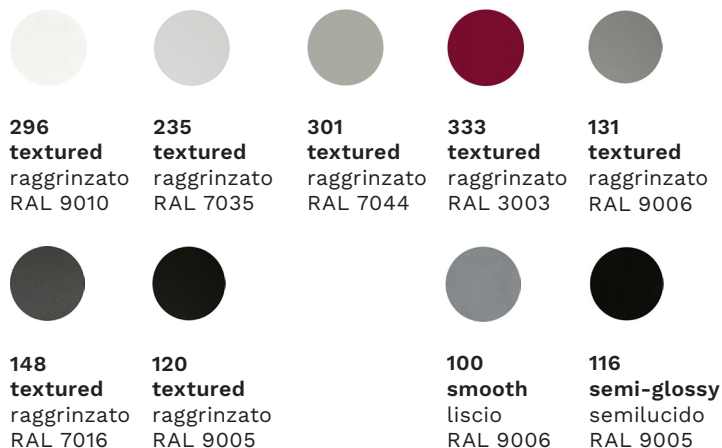

chromed steel
acciaio cromato



TOP / PIANO

standard colour and material effect laminate tops
piani standard in laminato colore ed effetto materico



standard colour and wood melamine tops
piani standard in nobilitato colore e legno



CLEANING AND MAINTENANCE / PULIZIA E MANUTENZIONE

STEEL / ACCIAIO

en Our types of metals include: chromed metals and painted metals. Do not use acid or alkaline based cleaning products. Do not use detergents, steel wool, dishwashing detergents or the like. Sharp or pointed objects may damage the surface. Any hot or wet object may cause surface damage. Clean the surface regularly with a soft cloth to remove dust. To remove light dirt, use a soft cloth and a neutral household cleaner.

it Le nostre tipologie di metallo comprendono: metalli cromati e metalli verniciati. Non utilizzare prodotti per la pulizia a base acida o alcalina. Non utilizzare detergenti, lana di acciaio, detersivi per stoviglie o simili. Oggetti appuntiti o taglienti possono danneggiare la superficie. Qualsiasi oggetto caldo o bagnato potrebbe provocare danni alla superficie. Pulire la superficie regolarmente con un panno soffice per rimuovere la polvere. Per rimuovere lo sporco leggero utilizzare un panno soffice e un prodotto per le pulizie di casa neutro.

CHROMED STEEL AND ALUMINIUM POLISHED / ACCIAIO CROMATO E ALLUMINIO LUCIDO

en Do not use acid or alkaline based cleaning products. Do not use detergents, steel wool, dishwashing detergents or the like. Sharp or pointed objects may damage the surface. Any hot or wet object may cause surface damage. Clean the surface regularly with a soft cloth to remove dust. To remove light dirt, use a soft cloth and a neutral household cleaner

it Non utilizzare prodotti per la pulizia a base acida o alcalina. Non utilizzare detergenti, lana di acciaio, detersivi per stoviglie o simili. Oggetti appuntiti o taglienti possono danneggiare la superficie. Qualsiasi oggetto caldo o bagnato potrebbe provocare danni alla superficie. Pulire la superficie regolarmente con un panno soffice per rimuovere la polvere. Per rimuovere lo sporco leggero utilizzare un panno soffice e un prodotto per le pulizie di casa neutro.

LAMINATE AND MELAMINE / LAMINATI E NOBILITATI

en Laminates and melamine products guarantee high performance in terms of resistance to scratches, shocks and abrasions. Keep furniture away from direct sunlight; furniture in direct sunlight may tend to discolour over time. Do not use acid or alkaline based cleaning products. Sharp or pointed objects can damage the surface. Laminate and melamine furniture can be cleaned using a mixture of liquid soap and hot water. Rinse with cold water and dry with a paper towel or damp cloth.

it Laminati e nobilitati garantiscono alte prestazioni di resistenza ai graffi, agli urti e alle abrasioni. Mantenere i mobili lontani dalla luce diretta del sole; i mobili che si trovano alla luce diretta del sole potrebbero tendere a scolorire nel tempo. Non utilizzare prodotti per la pulizia a base acida o alcalina. Oggetti appuntiti o taglienti possono danneggiare la superficie. E' possibile effettuare la pulizia dei mobili in laminato e nobilitato usando una miscela di sapone liquido e acqua calda. Sciacquare con acqua fredda e asciugare con un tovagliolo di carta o un panno umido.

TOP ACCESS
PASSACAVI

511E

mara[®]

DESCRIPTION / DESCRIZIONE

en Aluminium top access with flap. Black brush.

it Passacavi in alluminio con spazzola nera.

Surface cut-out area

Area di taglio della superficie

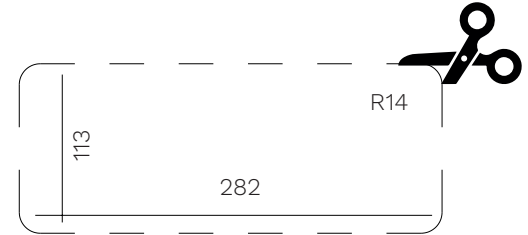
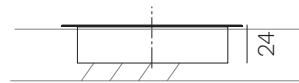
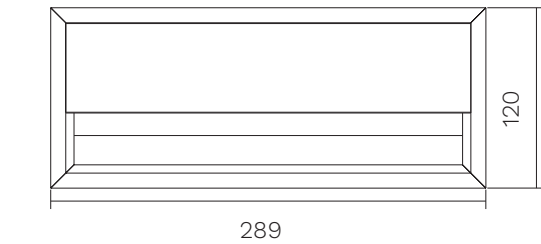

All measurements are indicated in mm
Tutte le misure sono indicate in mm

COLOURS AVAILABLE / COLORI DISPONIBILI



aluminium
alluminio



black
nero



TOP ACCESS WITH INTEGRATED POWER UNIT PASSACAVI CON MULTIPRESA INTEGRATA

mara®

511EPLUS

DESCRIPTION / DESCRIZIONE

en Top access with integrated power unit for table tops max 30 mm thick, available in aluminium or black colour, 289x120 mm with 2 mt. power cable + 2 DE sockets + 2 USB 5V/2, 4A + 2 RJ45 sockets.

it Passacavo con multipresa integrata per piani tavoli spessore max 30 mm, disponibile nei colori alluminio o nero, 289x120 mm con 2 mt. di cavo di alimentazione + 2 presa DE + 2 prese USB 5V/2, 4A + 2 prese RJ45.

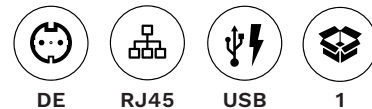

**Optional
(on demand)*:**
Opzionali
(su richiesta)*:

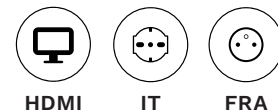

* dedicated quotation /quotazione dedicata

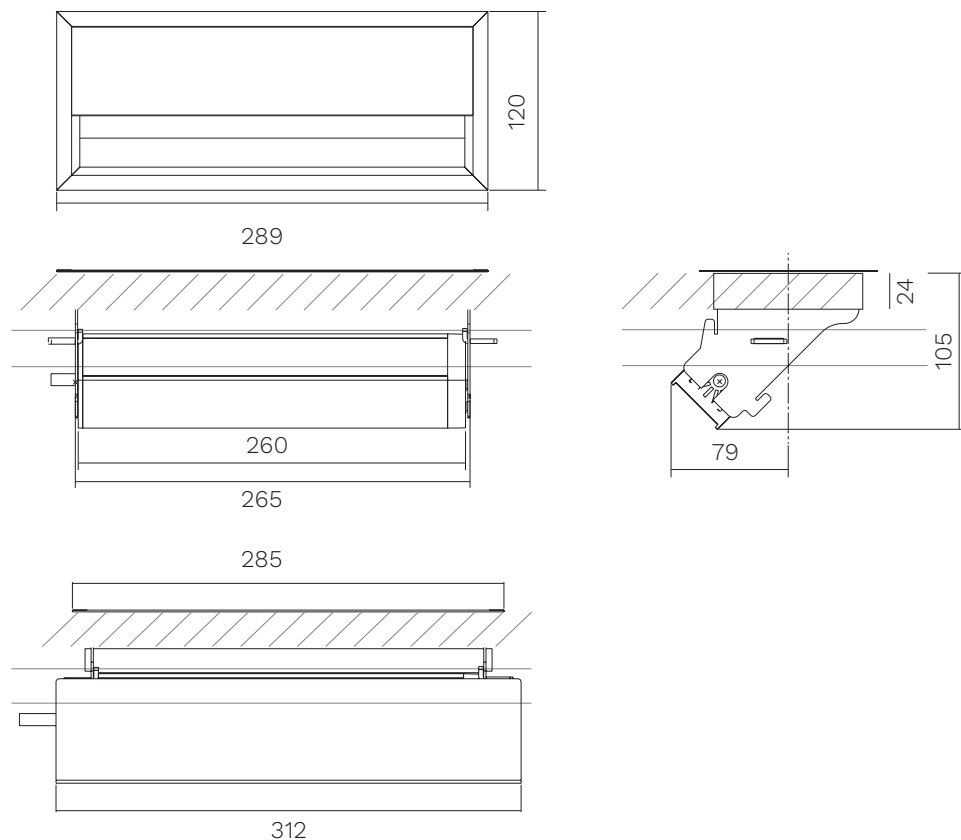

Surface cut-out area

Area di taglio della superficie

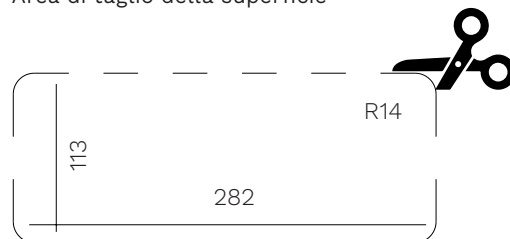

All measurements are indicated in mm
Tutte le misure sono indicate in mm

COLOURS AVAILABLE / COLORI DISPONIBILI

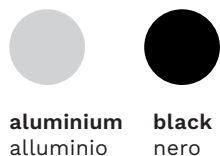

TOP ACCESS WITH INTEGRATED MULTIFUNCTIONAL SOCKET

PASSACAVI CON MULTIPRESA INTEGRATA

mara®

PASD60

DESCRIPTION / DESCRIZIONE

en Top access round with integrated multifunctional socket for table tops, available in white or black colours, diameter 60 mm with 2 mt. power cable + 1 DE + 1 USB 5V/2, 4A.

it Presa multifunzione rotonda per piani tavoli, disponibile nei colori bianco o nero, diametro 60 mm con 2 mt. di cavo di alimentazione + 1 presa DE + 1 presa USB 5V/2, 4A.

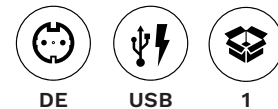

Optional (on demand)*:
Opzionali (su richiesta)*:

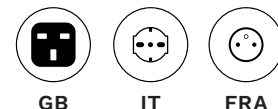

* dedicated quotation /quotazione dedicata

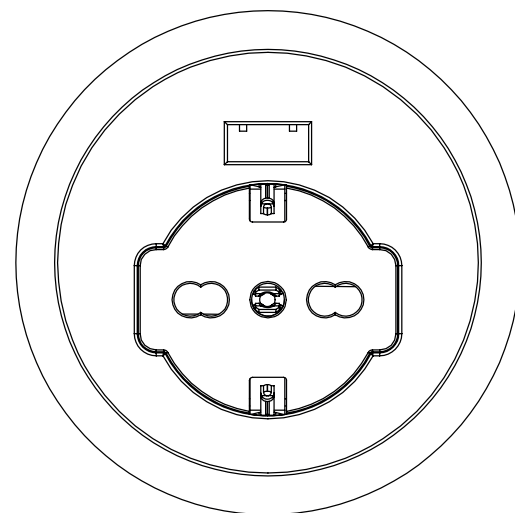
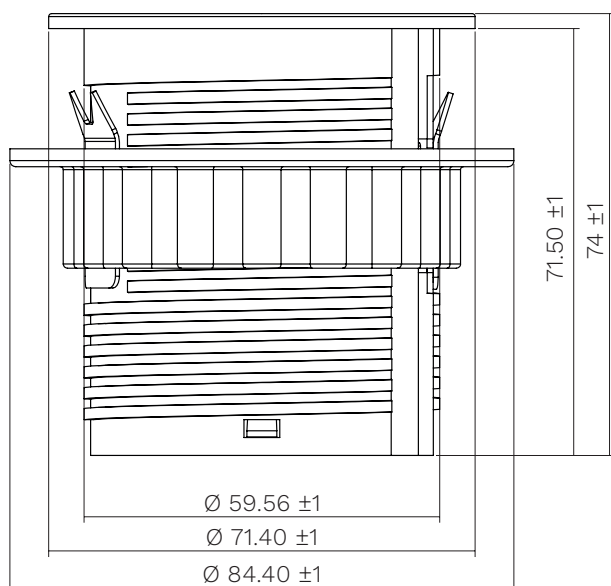

Surface cut-out area

Area di taglio della superficie

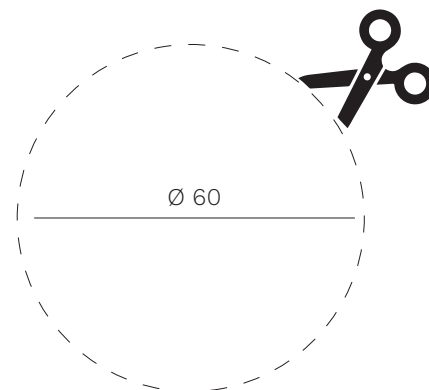

All measurements are indicated in mm
Tutte le misure sono indicate in mm

COLOURS AVAILABLE / COLORI DISPONIBILI

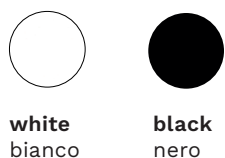

REV032023

MARA SRL | Via Adua 11, 25050 Passirano (BS) Italy | T. +39 030 6857568 | marasrl.it

CABLE MANAGEMENT WITH INTEGRATED MULTISOCKET PASSACAPO CON MULTIPRESA INTEGRATA

mara[®]

PASD80

DESCRIPTION / DESCRIZIONE

en Top access round with integrated multifunctional socket for table tops, available in white or black colours, diameter 80 mm with 2 mt. power cable + 1 DE + 1 USB 5V/2, 4A socket + 1 RJ45 (interchangeable). The inside of the cover is equipped with a wireless charger (usable only when open).

it Presa multifunzione rotonda per piani tavoli, disponibile nei colori bianco o nero, diametro 80 mm con 2 mt. di cavo di alimentazione + 1 presa DE + 1 presa USB 5V/2, 4A + 1 presa RJ45 (intercambiabile). L'interno del coperchio è provvisto di caricatore wireless (utilizzabile solo quando aperto).



wireless recharge

RJ45

DE

USB

1

Optional (on demand)*:
Opzionali (su richiesta)*:

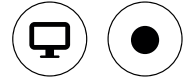

HDMI

EXIT

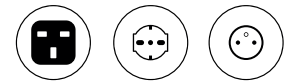

GB

IT

FRA

* dedicated quotation and minimum order
* quotazione dedicata e minimo d'ordine

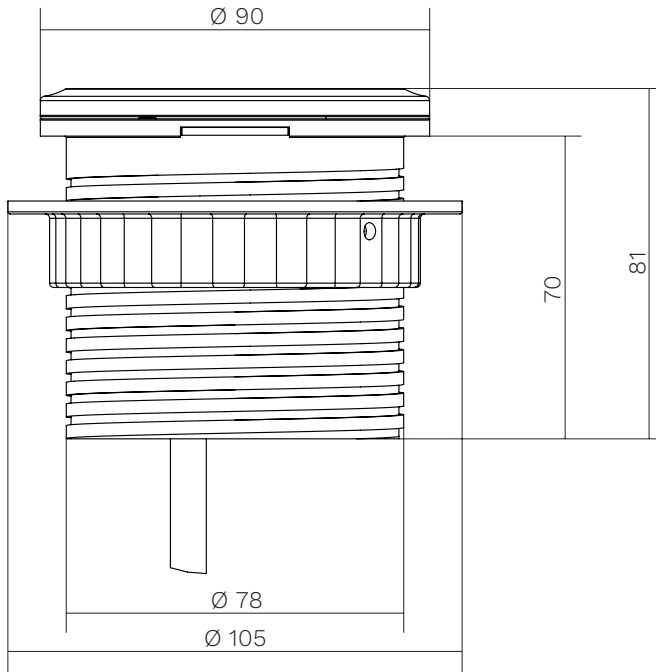

All measurements are indicated in mm
Tutte le misure sono indicate in mm

COLOURS AVAILABLE / COLORI DISPONIBILI



white
bianco



black
nero

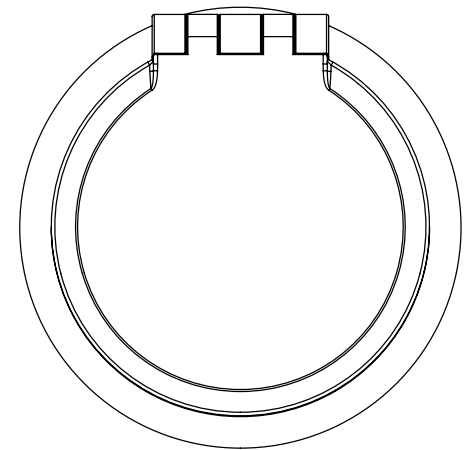

Surface cut-out area
Area di taglio della superficie

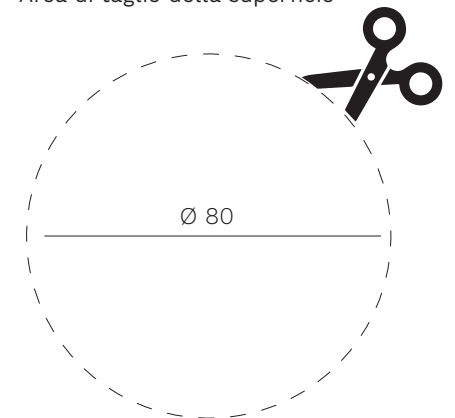



en All the energy used in our company is 100% green and comes exclusively from renewable sources.

it Tutta l'energia utilizzata nella nostra azienda è 100% GREEN e proviene esclusivamente da fonti rinnovabili.

en As it is always seeking to improve its products, the company reserves the right to modify or upgrade the products without prior notice, at any time. Colors should be considered purely indicative. Mara's Collections are worldwide protected by the industrial property right and patents.

it Mara, sempre alla ricerca del miglioramento dei propri prodotti, si riserva la facoltà di apportare modifiche costruttive e funzionali in qualsiasi momento senza alcun preavviso. I colori dei materiali sono da ritenersi puramente indicativi. Tutte le collezioni Mara sono protette nel mondo dal diritto di proprietà industriale e da brevetti registrati.